



Step Up Your Business

Complete end-to-end corporate solutions for workplace resilience and cross-team collaboration

BenQ



Get work done with BenQ

BenQ understands business. For the last 36 years, our enterprise-grade projectors and monitors have been helping companies get ahead of the curve. Over the last decade, we've branched out to develop and deliver even better display solutions that are designed to boost productivity and improve the utility of your existing workspaces. More than just your standard TV or signage, BenQ's corporate interactive and non-touch displays come with innovative hardware and software features that help you work smarter and enhance the quality of your output.

Future-proof your business

Change is inevitable. The question is, are you ready for it? For your organization to thrive amid challenges, your teams need to be equipped with flexible and agile solutions that allow them to quickly shift to more resilient working modes such as hybrid working for better business continuity.

Cover all the bases

Whether you're planning to give your entire office an upgrade or just looking to furnish your meeting rooms, BenQ offers a complete solutions portfolio that covers all types of display needs. From eye-catching lobby signage, to high-quality video streaming setups, to interactive displays for hands-on coworking, we've got you covered.

Team up with industry leaders

BenQ display solutions are partnered with and certified by other industry leaders such as Microsoft, Amazon, and VMware, among others, guaranteeing exceptional performance and compatibility.

[BenQ Display Partners >>](#)



Our corporate solutions

Explore what BenQ can offer enterprises. More than just monitors or projectors, we provide display solutions that effectively transform the way you work.

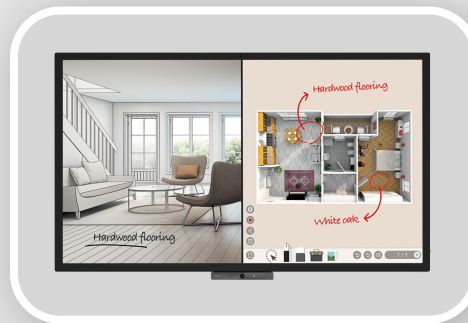

Interactive displays >

Push the limits of collaboration with touchscreen displays designed for real-time coworking in face-to-face and hybrid setups.



Corporate displays >

For digital office signage or large-format meeting room screens, BenQ's corporate displays are designed for versatility.



Accessories >

Extend the potential of your BenQ displays with add-ons that fulfill your most rigorous requirements.



Software >

With accessible apps and platforms purpose-built for collaboration and management, everything you need is at your fingertips.

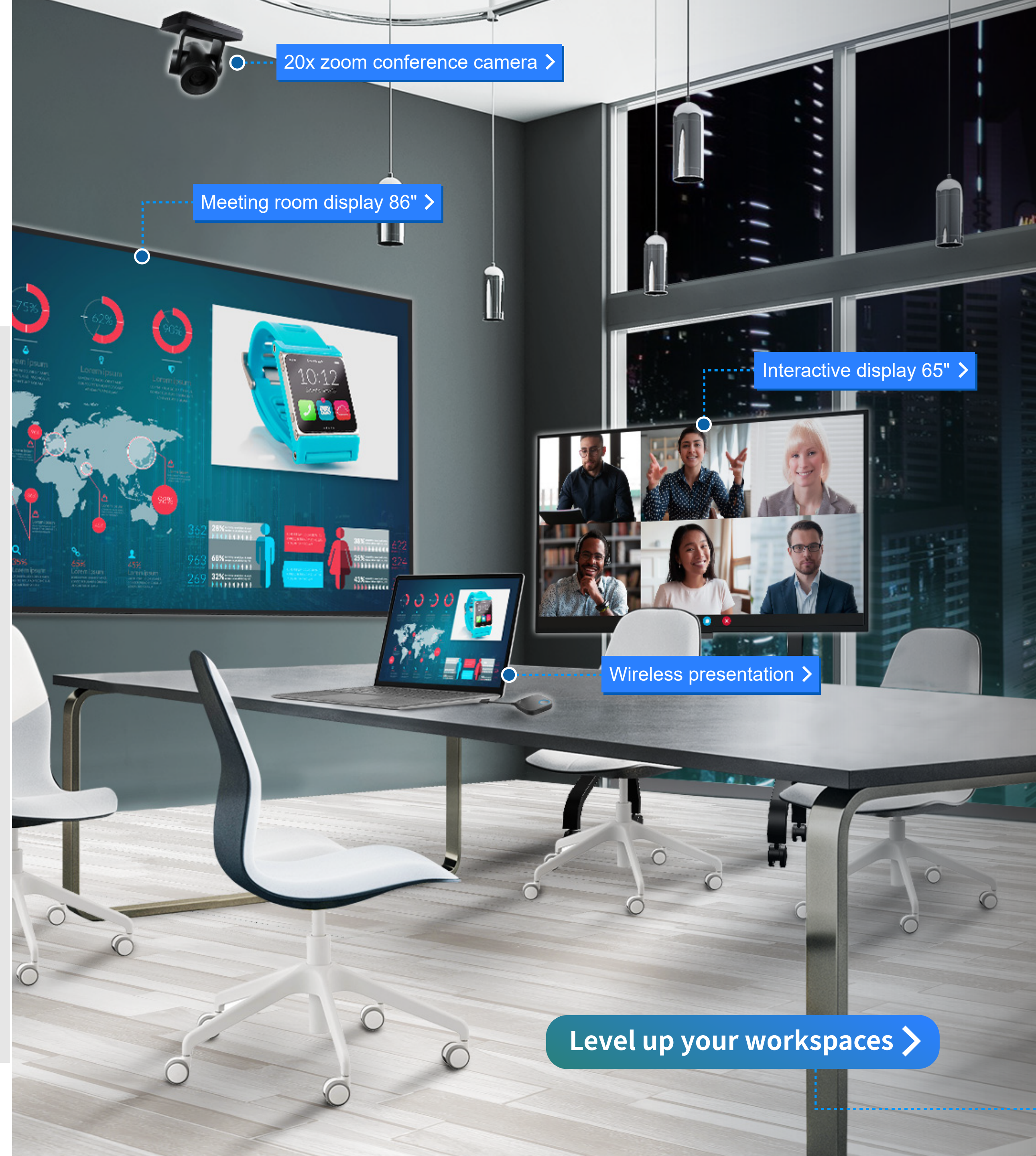

20x zoom conference camera >

Meeting room display 86" >

Interactive display 65" >

Wireless presentation >

Level up your workspaces >

Huddle room >

Have the freedom to explore ideas to the fullest in spaces designed for hands-on collaboration.



Meeting room >

With fully equipped rooms for presentations and conferencing, just walk in and start meetings instantly.



IT control room >

Monitor and manage enterprise assets with ease through an expansive live dashboard.



Entrance >

Protect the well-being of your employees and guests through no-contact temperature screening.

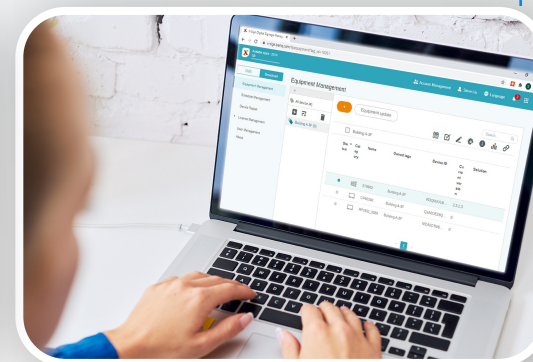
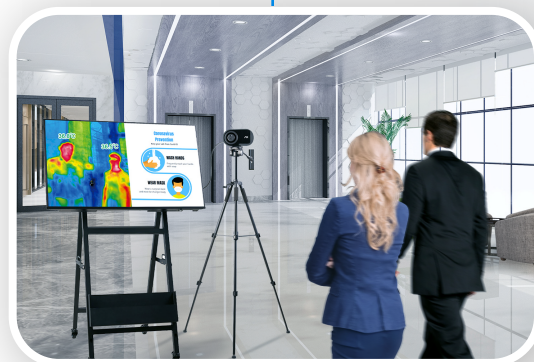

HR office >

Promote company advocacies and keep employees informed via a centralized broadcast system.

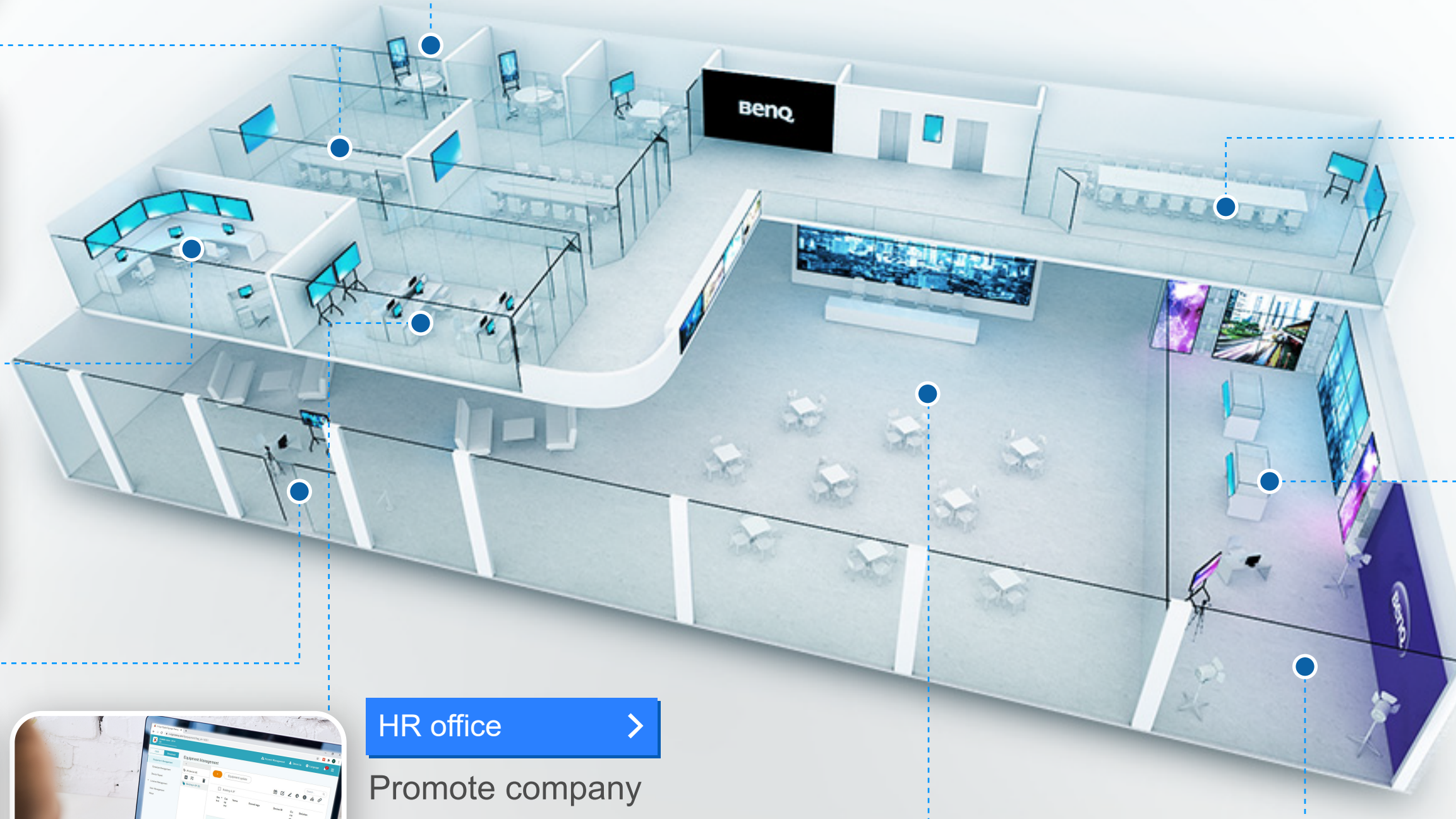

Conference room >

Get down to business without the fuss using professional display solutions for hybrid meetings.



Show room >

Sleek, color-calibrated displays and installations allow you to flaunt your finest products.



Demo room >

Host live demos and Q&As to reach more customers in real time via high-quality live streaming.



Lobby >

Impress guests with larger-than-life video walls that show off the best your company has to offer.



Level up your workspaces

BenQ offers a complete portfolio of enterprise-grade solutions that improve office spaces designed for different work scenarios.

Huddle room

small spaces for big ideas

— Display — Camera

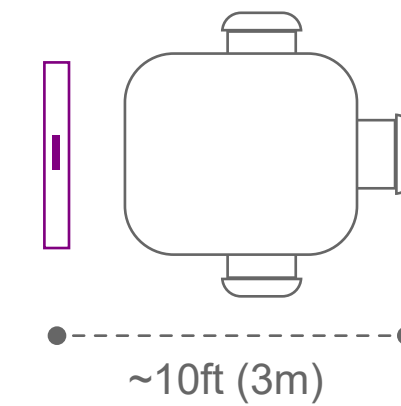

Accommodates
< 5 people

Viewing distance
~ 10ft (3m)

There's really no telling when a breakthrough will hit you. And when it does, you need to be ready to capture it and refine it with your peers.

Perfect for quick ad hoc meetings and impromptu brainstorming sessions, huddle rooms fitted with interactive touchscreen displays let coworkers explore ideas freely through cloud whiteboarding and other collaborative features.

[▶ CP product video](#)

[▶ EZWrite](#)





Next-level whiteboarding

Do more than just write. The BenQ DuoBoard comes with EZWrite, a cloud whiteboarding solution that allows multiple users to write or sketch on the same board at the same time, either directly on the DuoBoard or from their own mobile devices. EZWrite also allows you to extend your writing surface, import photos and screenshots, and record your sessions.

[Learn more >>](#)



EZWrite

Work that moves with you

Don't get stuck when you're on a roll. Mounted on the BenQ rotating display trolley, the DuoBoard becomes mobile. If ever you need to switch spaces, you can easily take your work with you and continue where you left off. And since the frame rotates up to 90°, you can whiteboard in portrait mode and see things from a different angle—literally.

[Available Q2 2021](#)



TTY21

Everything at a glance

Need to have multiple apps or files open for a project? Decrease the time it takes for you to keep switching from one window to another. Conveniently work on two apps at once using either the Duo Windows or Duo OS mode. Viewed on a large-format enterprise display such as the BenQ DuoBoard, you and your team can have more space to see all the details.

[Learn more >>](#)



DuoBoard 65"

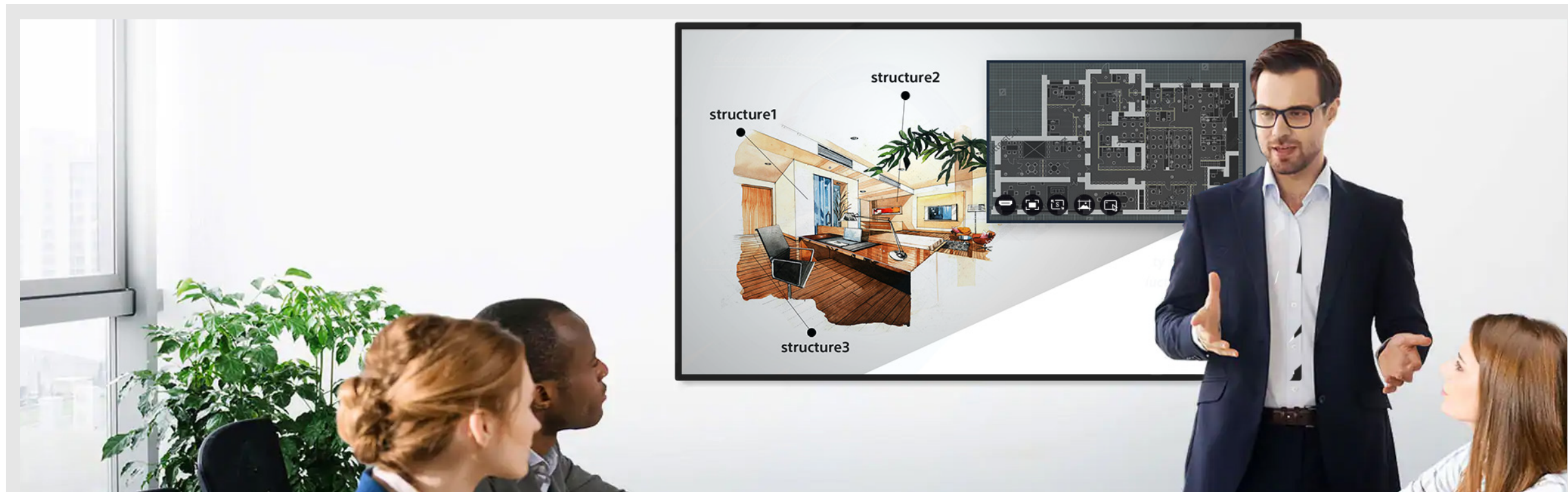

Looking for non-touch?

If you just need to present content, BenQ offers the CS, a professional meeting room display with features and add-ons that allow you to wirelessly share slides and multimedia files. It also supports the Duo working modes and cloud whiteboarding for on-the-fly collaboration.

[Learn more >>](#)



CS6501

Start video calls with ease

Pair the CS with the DVY21, a compact video conferencing camera that delivers Full HD video quality with a wide field of view. It's perfect for one-on-one meetings and small group sessions.

[Learn more >>](#)



DVY21



Meeting room

mid-size rooms for any purpose

— Display — Camera

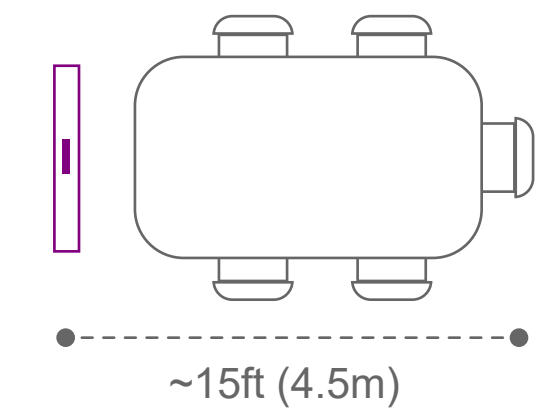

Accommodates
< 10 people

Viewing distance
~ 15ft (4.5m)

The most common of all office spaces, meeting rooms give employees a private area to share ideas, present plans, and discuss concerns with their colleagues.

Great meeting rooms allow just about anyone to walk in and start their presentations or video calls without getting bogged down by hardware or software issues. With this in mind, it's important to equip these spaces with displays designed for easy screen sharing and smooth video conferencing.

[▶ CS demo video >](#)

[▶ InstaShare 2 >](#)



Present with confidence

Focus on your meetings and BenQ will take care of the rest. Made for instant in-person and hybrid meetings, the CS has its own user-friendly OS that allows you to start video calls directly from the display or load presentations from your cloud storage accounts. You no longer need to bring laptops or USB drives. The CS also simplifies navigation and annotation. It comes with a powerful remote control that functions as a clicker and pointer.

[Learn more >>](#)



CS7501

Engage more people

Get your coworkers more involved. With InstaShare, you and your peers can quickly and simultaneously cast multiple device screens on the CS. This way, everyone can actively take part and contribute to the conversation. Also, since you can split the screen into segments, it's easy for everyone to view different content. This is useful when your team needs to refer to multiple sources for an ongoing task.

[Learn more >>](#)



BENQ

InstaShare

Book rooms with ease

Ever had trouble finding a room for your meeting? The CS integrates with solutions like Meeting Room 365 that let you provision meeting room displays for official business. Whether your office uses Google Workspace, Microsoft Outlook, Exchange, or Office 365, all you need to do is book a room and timeslot to reserve a display. The built-in CS widget automatically shows the room schedule so everyone is up to date.

[Learn more >>](#)

meetingroom³⁶⁵



Push and share

Not a fan of apps? You can still enjoy the benefits of InstaShare without installing it on your device. With the BenQ InstaShare Button, you just need to plug it into your phone or laptop and press the button to cast your screen. It works seamlessly with Windows, macOS, and other systems.

[Available Q4 2021](#)



TWY31

Get everyone in the frame

Equip meeting rooms with the DVY22, a 4K conference camera that's so smart, it adjusts the framing to the number of people in the room. It also has noise suppression and 4x digital zoom, making it silent yet powerful.

[Learn more >>](#)



DVY22



Conference room

large rooms for hybrid workgroups

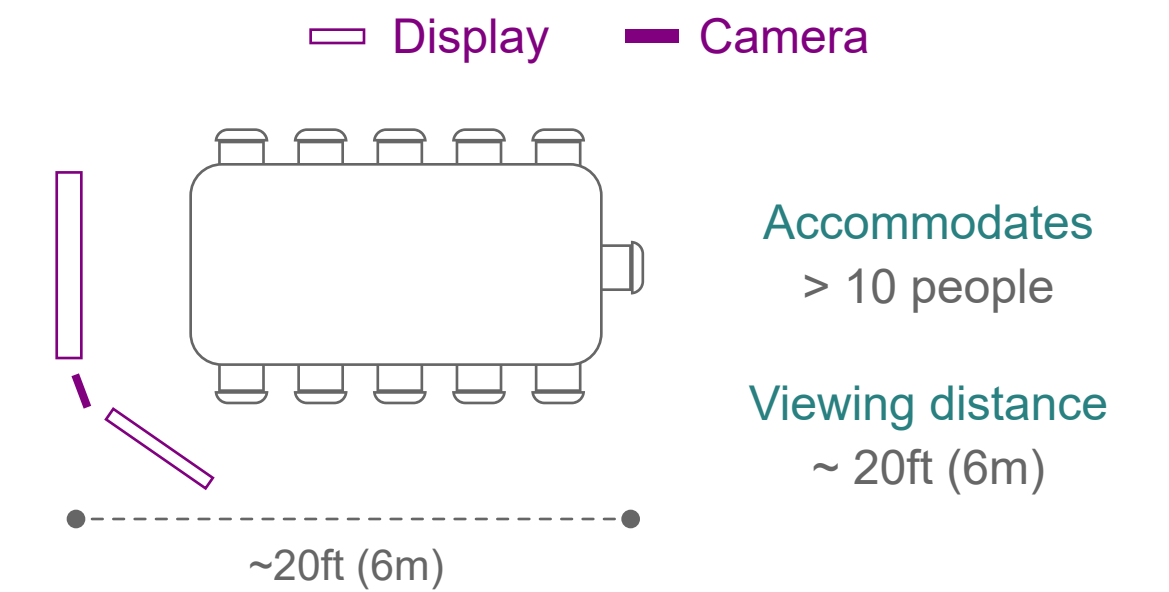

A state-of-the-art screen in your conference room may look impressive, but is it future-proof enough to withstand the current shift to hybrid work? With large workgroups scattered across different locations, it becomes a challenge to reach a consensus. How do you gather everyone in the same room at the same time? Furnish your conference room with professional display solutions that allow you to present to peers in person while also reaching remote collaborators through video conferencing.

[▶ CP product video](#)

[▶ Camera brochure](#)



Meet your way

Our corporate meeting room displays are built to impress. They're 4K, durable, and look professional, but more than all that, they're also designed to match how your teams work. BenQ knows that there's no one way to hold meetings, more so hybrid meetings. Everyone has a working style that suits them best: Some get results by whiteboarding in small groups, while others get things done by presenting ideas to a large audience. In any scenario, we have displays—both touch (DuoBoard) and non-touch (CS series)—that are guaranteed to fill your meeting requirements.

[Learn more >>](#)

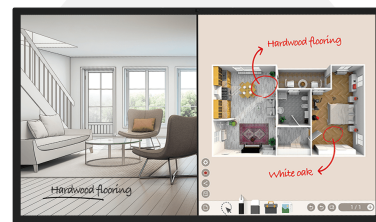

DuoBoard 65"



CS8601



Capture the action

A lot of meaning is conveyed via facial expressions and body language, which are often lost when talking to remote peers. In hybrid working scenarios, where teams are scattered across different locations, it's crucial for everyone to see each other. BenQ offers a selection of video conferencing cameras that suit different kinds of meeting rooms and scenarios. Whether you're alone in a meeting pod or sharing a large conference room with your team, there's a BenQ camera that's right for you.

[Learn more >>](#)



DVY21



DVY22



DVY23



Enjoy instant video conferencing

Start video calls right from your display. Both the DuoBoard and CS support instant video conferencing through the pre-installed TeamViewer Meeting. Just launch the app to securely collaborate with your remote team members and stakeholders. You no longer need to set up your laptop or mobile device.

[Learn more >>](#)



TeamViewer Meeting



Use the apps you have

Is your company requiring you to use Zoom Rooms, Microsoft Teams, Google Meet, Cisco Webex or other conferencing apps? With the TEY21, you can open any video conferencing software on the DuoBoard or the CS series. This OPS slot-in PC is loaded with Windows 10 IoT Enterprise, allowing you to not only use your preferred conferencing platform, but you can also open project files directly on your display. The TEY21 is easily accessible via the BenQ Launcher.

[Available Q2 2021](#)



TEY21

OPS supported software:



zoomrooms





Demo room

streamlined showrooms

Display Camera



Traditionally, exhibitions were the best way to let people experience your products firsthand and give them an idea of what you can offer them as a company. But when meeting potential customers in person is not a viable option, your sales and marketing teams can host livestreamed demos in a multipurpose visual space that doubles as a showroom and studio. Deck out this space with a display and streaming camera that present your products in the best light.

 DVY23 >

High-quality video streaming

Have no trouble broadcasting your demos on platforms like YouTube or Facebook Live with the DVY23 and TEY21. Combining the BenQ ST series display with a camera and OPS slot-in PC, you get the complete video streaming setup. The DVY23 is a 20x zoom conference camera with an extra wide range of pan, tilt, and zoom controls. It ensures that your presenters and products are always in focus and on screen. Its built-in gravity sensor also lets you to mount it in any position without affecting your video's quality and orientation. The TEY21 slot-in PC lets you can access web-based platforms so you can stream instantly.

[Learn more >>](#)



DVY23

More than just video assist

Video assist systems are helpful in demos since they provide real-time playback of your stream, but often, VA monitors are too small, limiting the number of people who can see what's being broadcasted. With a multipurpose UHD display like the BenQ ST series, you can monitor your livestream in crisp 4K clarity. And because it's a large-format display, the director and production crew can easily spot all the nitty-gritties. There's also more space for live feedback. Sales and marketing representatives can monitor the comment stream and easily field customer questions as they come in.

[Learn more >>](#)

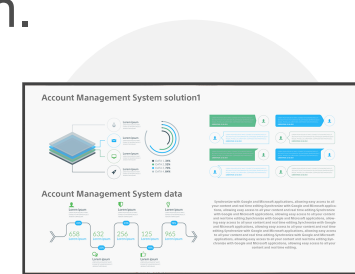

ST6502



TEY21

Increased interactivity for high-impact demos

Good sales demos tell a story. Great demos captivate their audience. With the RP series, it's easier to stage highly engaging visual presentations. Its touchscreen interface allows presenters to control their slides with hand gestures and move on-screen objects around directly from the display. The RP series is also fitted with an anti-glare screen, which is ideal for studio setups that require bright lights. Product videos and presentations stay visible under any lighting condition.

[Learn more >>](#)



RP8602



Captivate your audience

Products come to life on the Pantone® Validated SL series. Suitable for showrooms and exhibitions, the display's multiple color modes bring vibrancy to both still images and dynamic videos, effectively capturing your customers' attention.

[Learn more >>](#)

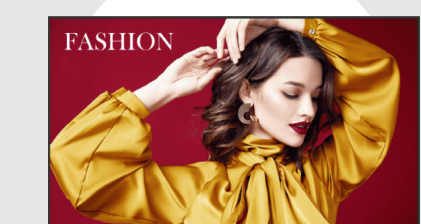

SL8602K

Create riveting experiences

Think outside of the box with creative installations. The BH series—BenQ's smart stretched signage—offers versatility, giving you the freedom to set up immersive showrooms that excite the senses.

[Learn more >>](#)



BH2801



Lobby



Entrance

Make a great first impression

The moment your guests enter your lobby, give them a glimpse of what you can offer through an eye-catching video wall that promotes both your company's solutions and brand identity. And since the BenQ PL video wall series has one of the thinnest bezels in the industry, you're guaranteed a large seamless, distortion-free image. You can further maximize this space by switching up content and using the wall as a large wayfinding sign and digital announcement board.

[Learn more >>](#)



PL5502

Protect employee health

As businesses weather the COVID-19 pandemic, it has become their utmost priority to guarantee the health and safety of their office guests and employees. To help maintain a healthy work environment, BenQ offers enterprises a complete contactless temperature screening solution. The DVY24 is a powerful thermal camera that covers a wide field of view and provides quick accurate readings. It comes with the ST and an OPS slot-in computer for real-time display of results and the Easy-to-Go stand for mobility.

[Learn more >>](#)



DVY24



IT control room

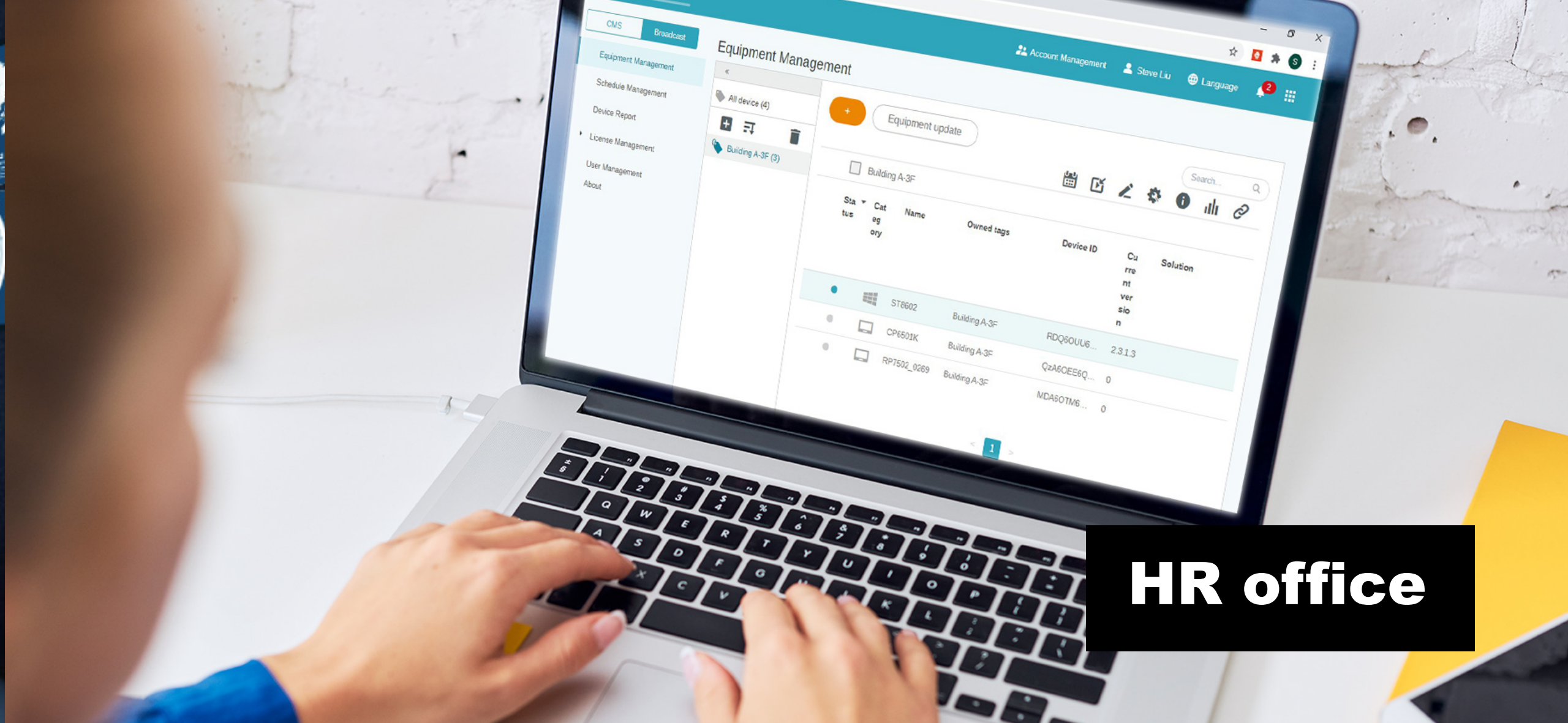

HR office

Centralized device and user management

Equip your IT teams with a command center fit for enterprises. The BenQ DMS (Device Management Solution) and IAM (Identity and Access Management) service streamline device and permissions management by allowing IT staff to modify device settings and sync Active Directory user lists via a single, secure cloud-based console. You can display the device dashboard together with live security feeds on a large video wall for real-time monitoring. This ensures that company assets are being used properly and optimally.

[Learn more >>](#)



PL5502



DMS

Effective officewide communication

HR teams usually keep employees up-to-speed regarding corporate updates, employee benefits, training schedules, and other events via email and official portals. These blasts often get buried under other work-related threads. Make efficient use of your BenQ displays and signage when they're on standby by pushing news and company-wide announcements for everyone to see. You can easily draft and publish content using X-Sign or send out high-level alerts that need immediate action using X-Sign Broadcast.

[Learn more >>](#)

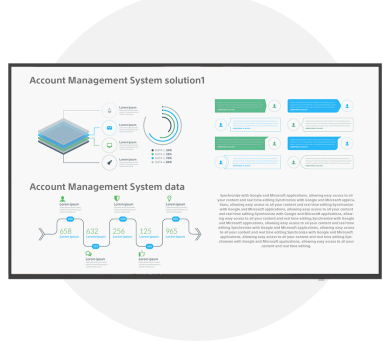

ST5502



X-Sign Broadcast

Interactive Displays

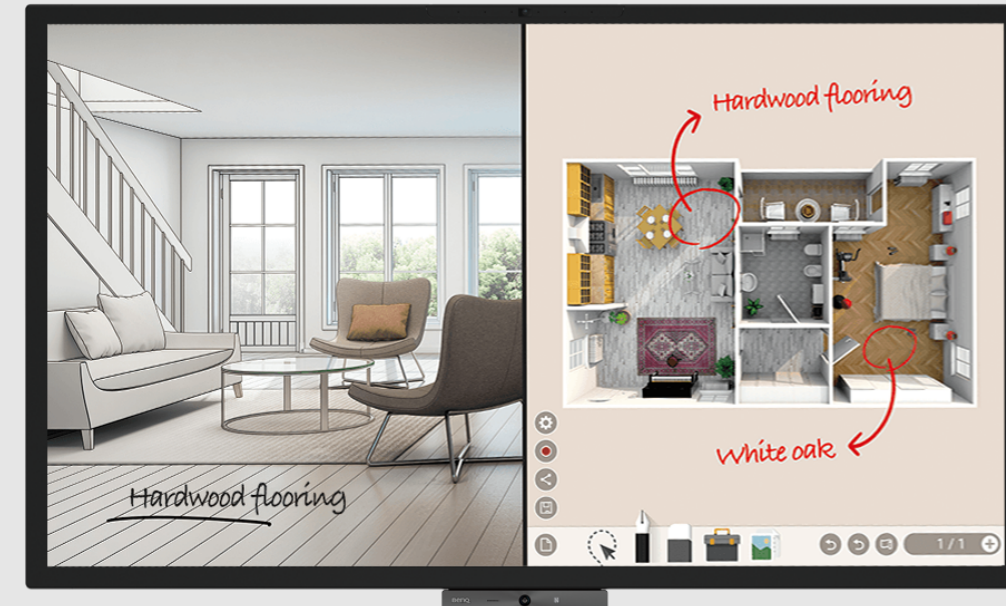

DuoBoard
Corporate interactive display

- Multitask with peers using the different Duo modes
- Use work apps on the display via the slot-in PC
- Instantly host calls using the built-in mic and camera
- Protect user health with the germ-resistant screen
- Sizes: 65", 86"

[More info](#)



RP series
Corporate interactive display

- Instantly access your cloud accounts via NFC login
- Use work apps on the display via the slot-in PC
- Protect user health with air quality sensors and the germ-resistant screen
- Brightness adjusts according to user proximity
- Sizes: 65", 75", 86"

[More info](#)



RM series
Corporate interactive display

- Provides a smooth writing experience
- Use work apps on the display via the slot-in PC
- Protect user health with the germ-resistant screen
- Conveniently comes with speakers and pen tray
- Sizes: 55", 65", 75", 86"

[More info](#)

* Model availability based on region

Corporate Displays



CS series

Corporate meeting room display

- Cast and control your presentations with ease
- Use your preferred video conferencing app via the slot-in PC
- Collaborate using intuitive meeting tools
- Sync and display all your meeting schedules
- Sizes: 65", 75", 86"

[More info](#)



SL series

Pantone® Validated display

- World's first and only Pantone® Validated display
- Ensures end-to-end color fidelity
- Offers color modes for different scenarios
- Provides 4K UHD quality
- Sizes: 43", 55", 65", 75", 85"

[More info](#)

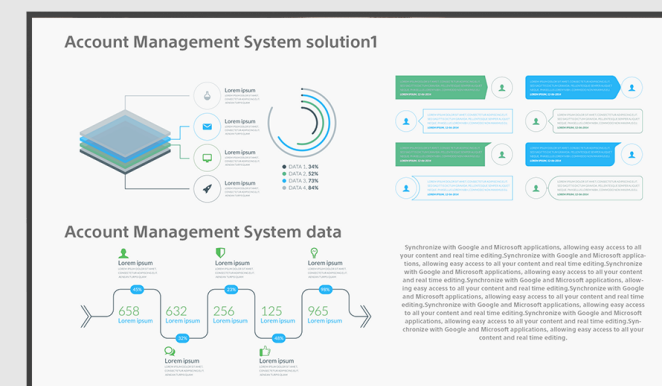

ST series

4K smart display

[More info](#)



PL series

Video wall

[More info](#)

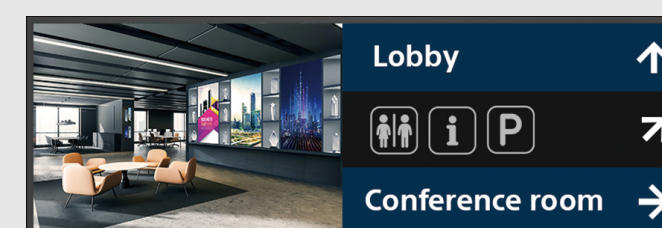

BH series

Smart stretched display

[More info](#)

- Designed for versatile use in corporate settings
- Ready-to-use with its built-in Android OS
- Easy playback with built-in player and speakers
- Provides 4K UHD quality
- Sizes: 43", 55", 65", 75", 86"

- Immersive viewing with 0.44 mm bezels
- Color-calibrated for image consistency
- Offers daisy-chaining with 4K clarity
- Flexible configuration of displayed content
- Supports content playback from USB
- Sizes: 49", 55"

- Comes in various sizes for diverse applications
- Clear images under different lighting conditions
- Single or double-sided depending on need
- Simple, streamlined design
- Optional touchscreen interactivity
- Sizes: 24", 28", 35", 38"

Accessories



DVY21
Compact Full HD webcam

- 88° wide field of view
- Clear Full HD video without distortion
- Omnidirectional microphones with noise suppression
- Adjusts to lighting conditions
- USB plug and play

[More info](#)

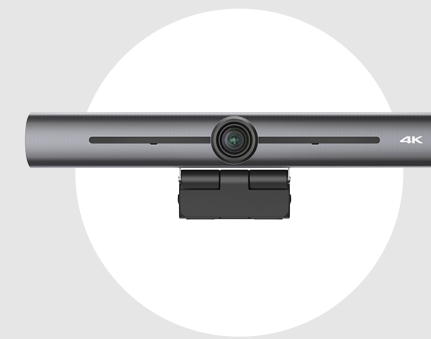

DVY22
Smart 4K
conference camera

- 126° wide field of view
- 4x digital zoom
- AI-powered auto framing
- Omnidirectional microphones with noise suppression
- Provides clear images even in dim lighting

[More info](#)



DVY23
20x zoom
conference camera

- Ultra-detailed 20x optical zoom
- Pan: ±170° | Tilt: -30° to +90°
- Video outputs: USB 3.0, HDMI, 1GbE with PoE, 3G-SDI
- Streaming: RTSP and RTMP
- Control ports: RS232, RS422, RS485, LAN, and remote control

[More info](#)



TWY31
InstaShare Button

- One-press screensharing on BenQ corporate displays
- Supports Windows, macOS, Chrome OS, Android, and iOS
- Pocket-sized and ultralightweight
- USB plug-and-play (Type-C)

[Available Q4 2021](#)



TEY21
OPS slot-in PC
Intel 10th gen i5 & i7

- Loaded with licensed Windows 10 IoT Enterprise
- Supports a wide variety of applications
- Accessible via BenQ Launcher
- Maximum resolution: 3840x2160
- Data ports: USB 3.1, 3.0, and 2.0, and HDMI

[Available Q2 2021](#)



TTY21
Rolling stand
with rotating mount

- Designed for easy mobility
- 90° maximum rotation
- Supports up to 45kg (98lbs)
- VESA-compatible (up to 600x400mm)
- Equipped with pedal brakes

[Available Q2 2021](#)



Software

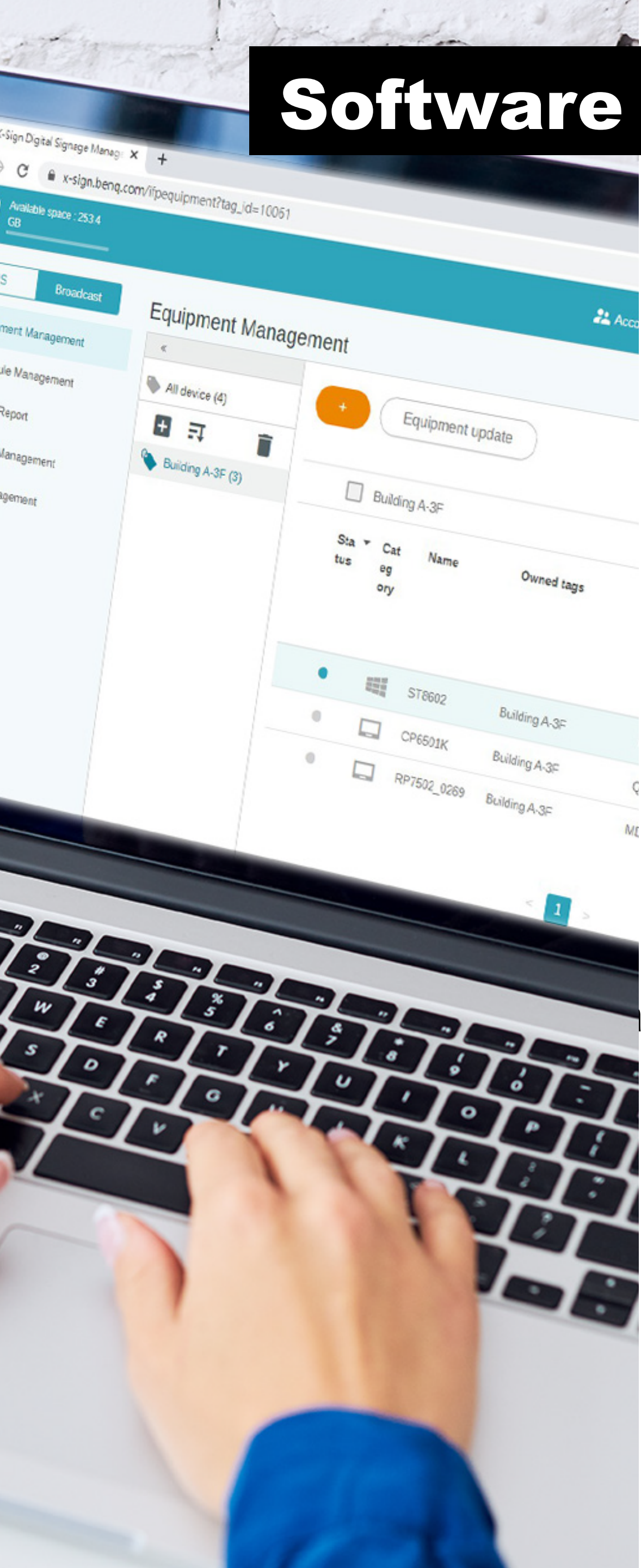

EZWrite

Write, draw, and insert images freely on a highly collaborative cloud whiteboard designed for BenQ displays.

[More info](#)



InstaShare

Instantly share and control multiple device screens—regardless of their OS—on your BenQ displays.

[More info](#)



DMS

Update firmware, manage apps, and control your devices through the BenQ device management solution.

[More info](#)

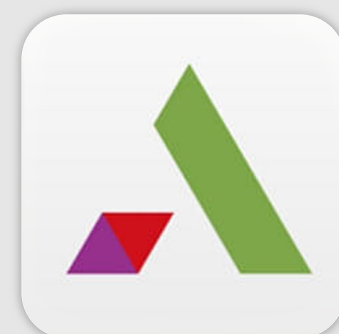

AMS

Link and access your cloud storage on your displays through the BenQ account management system.

[More info](#)



X-Sign Broadcast

Draft and push alerts and important announcements to all your BenQ displays via X-Sign Broadcast.

[More info](#)



X-Sign

Create, schedule, and publish content for your BenQ displays through the X-Sign content management system.

[More info](#)

BenQ Display Partners

BenQ has partnered with industry-leading manufacturers and cloud service providers to give you unparalleled service whenever you use any of our corporate display solutions.

[Learn more >](#)



BenQ slot-in PCs are powered by Intel, transforming displays into powerful IoT solutions.



AMS-hosted BenQ services guarantee data security, privacy, and reliability.



Defend your displays against malware while securing your corporate data.



Access virtual desktops on your displays to open hosted apps, files, and folders.



Enjoy enterprise-grade video conferencing with Zoom Rooms compatible BenQ displays.



Use TeamViewer solutions for remote desktop access or video conferencing.



Configure and manage your displays with ease using Crestron's secure ecosystem.



Manage and adjust your displays to your liking without having to switch system controllers.



The Pantone matching system ensures end-to-end color fidelity on BenQ solutions.

Solutions Summary



Huddle room

Meeting room

Conference room

	Collaboration	Collaboration	Collaboration
Interactive Displays	DuoBoard, RP, RM (65")	DuoBoard, RP, RM (65"/75")	DuoBoard, RP, RM (86")
Software	EZWrite	EZWrite	EZWrite
Accessories	Mobile stand	Mobile stand	Mobile stand
	Presentation	Presentation	Presentation
Non-Touch Displays	CS, SL, ST (43"/55"/65")	CS, SL, ST (65"/75")	CS, SL, ST (75"/86")
Wireless Presentation	InstaShare	InstaShare	InstaShare
Accessories	InstaShare Button Mobile stand	InstaShare Button Mobile stand	InstaShare Button Mobile stand
	Video Conferencing	Video Conferencing	Video Conferencing
Corporate Displays	CS, SL, ST (43"/55"/65") DuoBoard, RP, RM(65")	CS, SL, ST (65"/75") DuoBoard, RP, RM(65"/75")	CS, SL, ST (75"/86") Duoboard, RP, RM(75"/86")
Video Conferencing	Zoom Rooms, Microsoft Teams, Cisco WebEx, Google Meet, etc.	Zoom Rooms, Microsoft Teams, Cisco WebEx, Google Meet, etc.	Zoom Rooms, Microsoft Teams, Cisco WebEx, Google Meet, etc.
Accessories	1080P webcam Intel i7 slot-in PC	Smart 4K camera Intel i7 slot-in PC	20x zoom PTZ camera Intel i7 slot-in PC

BenQ